

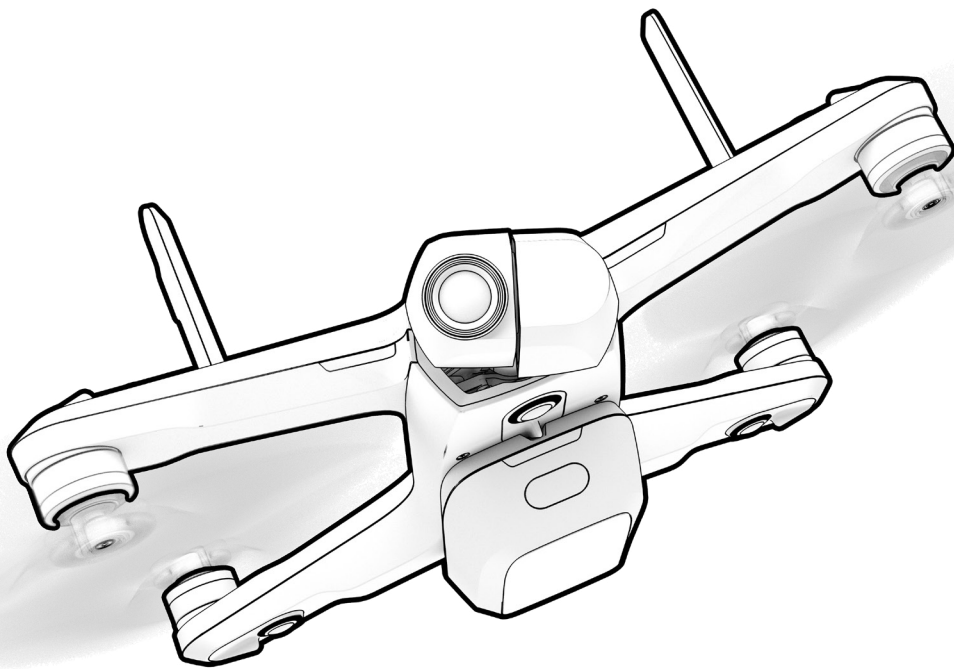

# Operator Manual

Skydio 2/2+



**WARNING:** Please read all documentation provided with your Skydio 2/2+ including but not limited to the Safety & Operating Guide found here: <http://skydio.com/getstarted2>



Updated: March 29, 2022

Version: 19.0

© 2021 Skydio, Inc. All rights reserved.

# Contents

---

## Overview

Skydio 2/2+ and Accessories..... 1

Skydio 2/2+ Hardware..... 2

## Safety

Safety Guidelines ..... 3

Flying Safely..... 4

## Pre-flight

Set Up..... 5

Activate the Skydio 2 app..... 7

Settings Menu ..... 8

Drone Settings Menu..... 8

Phone Settings Menu ..... 12

Controller Settings Menu..... 13

Anti-Flicker ..... 14

Channel Selection ..... 15

Return To Home ..... 16

Map View ..... 17

Pre-flight Inspection..... 18

## Flight

First Flight ..... 19

Hand Launch..... 20

Flight Screen ..... 21

Flight Controls ..... 21

Camera and Video Settings ..... 22

Recording Indicator..... 23

Signal Strength Indicator ..... 24

Battery Indicator..... 24

Flight Skills..... 25

General Skills ..... 25

Cinematic Skills ..... 26

Tracking a Subject..... 27

One-Shot Skills..... 28

# Contents

---

Specialty Skills.....	28
Land.....	29
Case Landing.....	30
Hand Landing .....	31
<b>Post-flight</b>	
Viewing and Saving Media .....	32
<b>Emergency Behaviors</b>	
Lost Connection .....	33
Lost Connection Return Behaviors .....	33
Lost GPS Behavior .....	34
Low Battery Behavior.....	34
Recovering a Lost Drone .....	35
<b>Maintenance</b>	
Battery safety guidelines.....	36
Replace Propeller Blades .....	37
Updating Your Drone .....	38
<b>Skydio 2 Specifications</b>	39
<b>Skydio 2+ Specifications</b>	42
<b>Legal</b>	45

# Overview

## Skydio 2/2+ and Accessories



### Skydio Starter Kit includes:

1. Skydio 2/2+ drone
2. Battery (1)
3. Custom Fit Hard-shell case
4. USB-C wall adapter
5. USB-C charging/data cable
6. Replacement propellers (2)

### Skydio Pro Kit includes:

- 2 additional batteries
- 1 Beacon
- 1 Joystick Controller
- 1 tablet adapter for Joystick Controller
- 1 Dual Charger
- 1 Pro Case
- 1 SD Card
- 1 set of PolarPro ND Filters
- 1 additional set of spare propellers
- Skydio Premier Support

# Overview

## Skydio 2/2+ Hardware

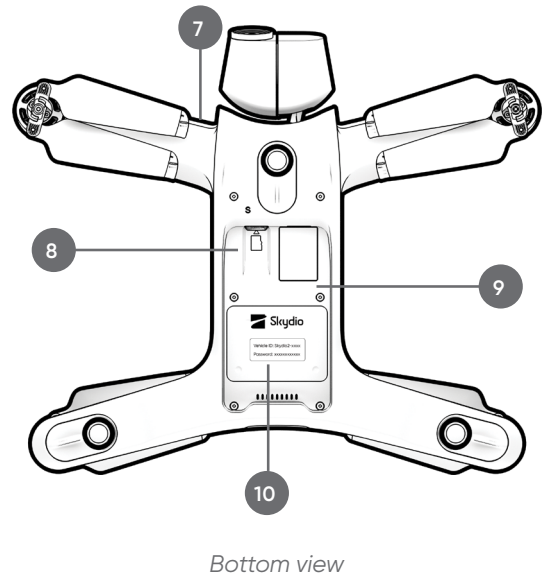
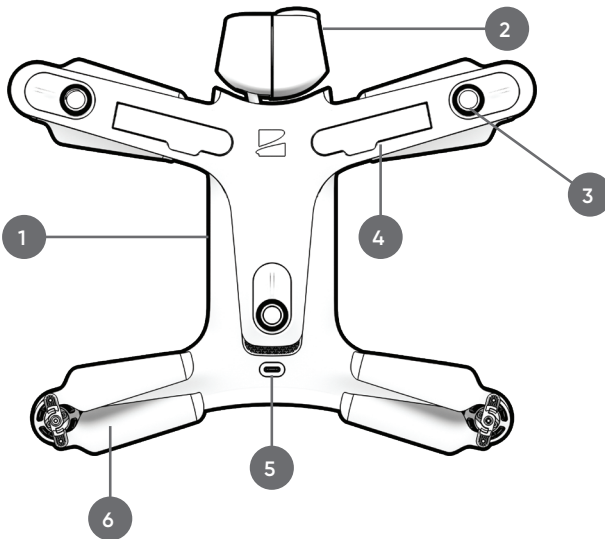

1. Chassis
2. Camera gimbal
3. Navigation camera (6)
  - 3 on top and 3 on bottom
4. Antennas (Skydio 2+ only)
5. USB-C port
6. Propeller hub with blades
7. Arm (4)
8. MicroSD memory card port
9. Battery tray
10. Vehicle ID and password



**CAUTION:** Skydio is not weatherproof. Do not operate in any precipitation, including rain, fog, snow, or similar environments. Do not rest in sand, dirt or on similar terrain where particles can get trapped in the fan.

# Safety

## Safety Guidelines

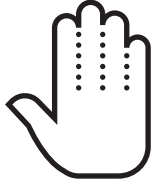

Keep your fingers away from moving propellers at all times.

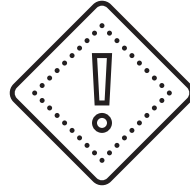

Use caution around reflective surfaces (still water, mirrors, etc.) and small obstacles (thin branches, utility lines, ropes, chain link fencing, etc.)

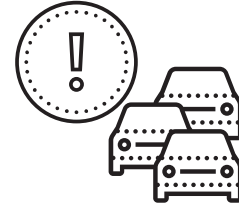

Skydio does not avoid moving objects or cars.



Skydio is not weatherproof – don't fly in rain, snow, fog, high winds, etc.

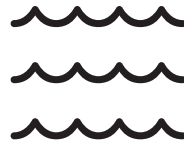

Before flying over water, ensure your drone has GPS lock. Launch and land your drone over a dry surface.

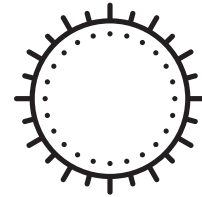

Don't fly in low-light conditions or in poor visibility.



Clean all of the cameras so Skydio can see clearly.

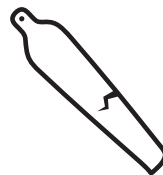

Check your propellers for damage before flying.



Follow all civil aviation authority regulations, as well as any applicable local and federal laws.

# Safety

## Flying Safely

### Pre-flight

- Ensure that all of the camera lenses are dust and smudge-free prior to flight.
- Inspect the battery magnets and connections for damage and debris prior to flight.
- Inspect propeller blades for nicks, cracks, or other visible damage prior to flight.
- Inspect the chassis for damage and debris prior to flight.
- Remove the gimbal retaining clip from the front-facing camera.
- Ensure any Battery Saver or Low Power modes are disabled on your mobile device. These modes may interfere with Skydio's ability to communicate with the device and negatively impact your flight experience.

### Environment

- Do not fly in precipitation, fog, or snow.
- Ensure flight environment has good visibility. Skydio can only fly in normal daytime conditions.
- Do not fly in extremely hot temperatures above 104°F (40°C).
- Do not fly in extremely cold temperatures below 23°F (-5°C).
- When flying in temperatures below 32°F (0°C) ensure your batteries are pre-warmed to 50°F (10°C) prior to takeoff.
- Avoid windy weather conditions, or gusts above 25 mph (40 km/h).
- Fly cautiously around reflective surfaces such as still water or mirrors. Before flying over water, ensure your drone has GPS lock. Launch and land your drone over a dry surface.
- Do not fly around objects less than .5 in (1.27 cm) in diameter such as thin branches, utility lines, ropes, netting.
- Do not fly around objects in motion such as cars, boats, balls, animals, or other drones.

### Warnings

- Fly cautiously around people.
- Avoid transparent or reflective surfaces, windows, or mirrors greater than 23 in (58 cm) wide.
- Avoid moving obstacles, cars, and animals.
- The pilot in command (PIC) is responsible for managing altitude, range, and battery level and monitoring in-app messages and alerts.
- Avoid flight in low-light conditions.
- Alert messages will display if Skydio determines the environment is not safe for flight.
- When instructed to do so, immediately fly Skydio to the safest area and land.
- Flying at high altitudes may significantly increase the time required to return and safely land.
- Propeller blades are sharp—handle with care.
- Skydio should not be used or handled by a person under the age of 18 years.

### Regulations

- Follow all civil aviation, such as the FAA or your countries regulatory agency, rules and regulations.
- You are responsible for your Skydio at all times. When operating your drone check [knowbeforeyoufly.org](https://knowbeforeyoufly.org/) / B4UFLY / CA-SA-verified before flying.
- **Keep your Skydio drone within visual line of sight at all times**, unless you have received express permission to fly beyond visual line of sight from a civil aviation authority such as the FAA.
- Do not fly in an environment where the use of the device is not authorized or restricted.



Visit <https://skydio.com/safety> and <https://skydio.com/support> for more information, helpful tips, videos, and articles.

# Pre-Flight

## Set-Up

### Step 1 - Insert a micro SD card into the memory card slot

- you may be required to format your card in the drone before flying
- Skydio will not fly without a properly formatted card

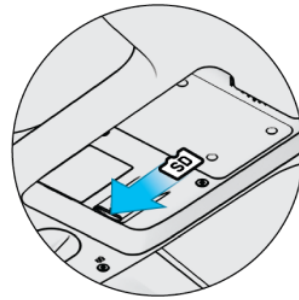

### Step 2 - Attach the battery to your drone

- the batteries are held in place with magnets
- firmly tug battery to remove

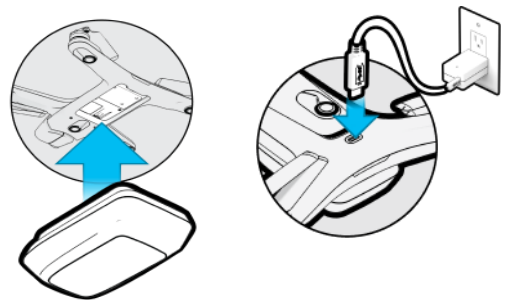

### Step 3 - Charge your battery using the USB-C cable and power adapter

- charge in an open area
- it is normal for the drone and battery to be warm during charging



Charging



Fully Charged

### Battery lights indicate the current state of charge

- lights on the battery will turn on and begin to flash at its current charge level. Flashing will continue until it turns solid, indicating charging is complete
- lights will remain solid for one minute and turn off when charging is complete
- lights on Skydio 2/2+ will turn on and remain solid blue until charging is complete



**CAUTION:** Remove the red plastic gimbal clip before charging.



# Pre-Flight

## Set-Up

**Step 4** - (Skydio 2+ only) Flip up antennas

- Gently lift each antenna and guide it into a vertical position

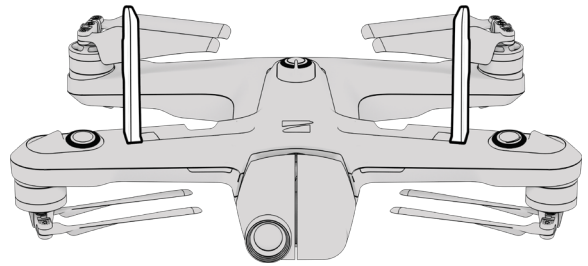
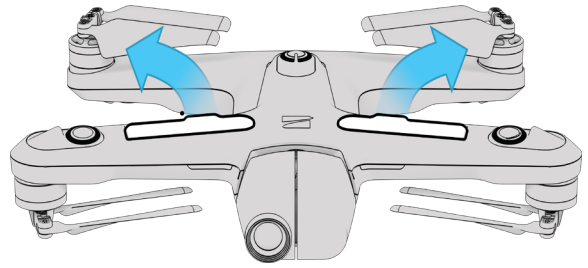

# Pre-Flight

## Activate the Skydio app

The Skydio app on your mobile device is used to fly your Skydio 2/2+, update your system, format your SD memory card, and view and manage your media.

### Step 1 - Install the Skydio app on your mobile device:

- available on the App Store® and Google Play
- compatible with iOS 12.0 or Android 9.0 (or later)

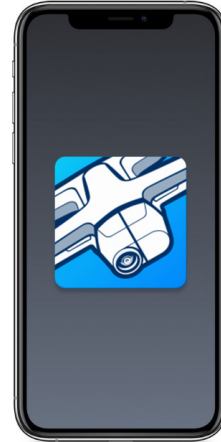

### Step 2 - Launch the Skydio app

### Step 3 - Enable location and microphone settings on your phone

- additionally, local networking on iOS

### Step 4 - Power on your drone

- press and hold the battery button for 3 seconds

### Step 5 - Activate your drone

- enter the email account you would like to be associated with your Skydio app
- Skydio will email you a unique registration code

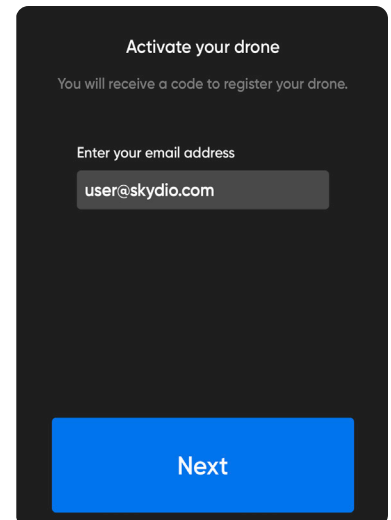

### Step 6 - Enter the code sent to your email

- select **Next**

### Step 7 - Enter your Skydio WiFi name and password when prompted

- located on the sticker attached to the drone or inside the battery tray
- remove the sticker attached to the drone before flying

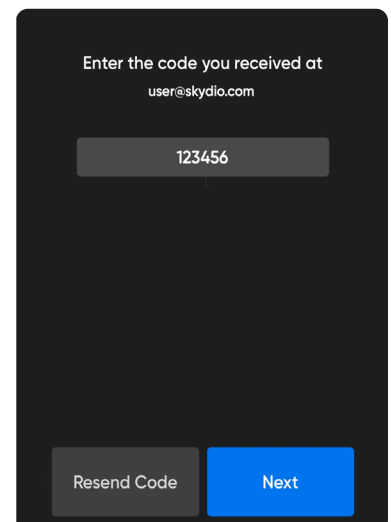

# Pre-Flight

## Settings Menu

Access in-flight settings for the drone, your phone, and the Controller (if connected).

## Drone Settings Menu

### Height Limits

#### Height Floor

- (Enabled by default) maintains at least 8 ft (2.4 m) of space above a tracked subject while in any autonomous follow skill, creating a buffer between Skydio and any moving objects, such as people, pets, or vehicles.
- You will be unable to lower the Height Floor below 8 ft (2.4 m) height floor while tracking a subject.
- While following a subject, Skydio may become trapped by obstacles and be unable to continue following due to the height restriction, even though the space underneath the drone is clear.

Disabling the Height Floor setting may increase tracking performance by allowing Skydio to fly under low-lying obstacles, such as tree branches and overhangs, to maintain a visual line of sight. It also allows users to set the preferred follow height low to the ground, capturing high-energy shots from a unique ground-hugging perspective.

**Skydio only avoids obstacles that are not in motion.** Cars, balls, animals, other drones, other people, or similar moving objects will not be avoided if they're moving faster than walking speed.

The combination of low elevation flight and high-speed tracking presents an increased risk of collision with moving objects. **Skydio, Inc. strongly recommends users only disable the Height Floor setting when operating in wide open, outdoor spaces with no other people, animals, or other moving objects nearby.** Pilots maintain full responsibility for the safe operation of their Skydio drone at all times during the flight.

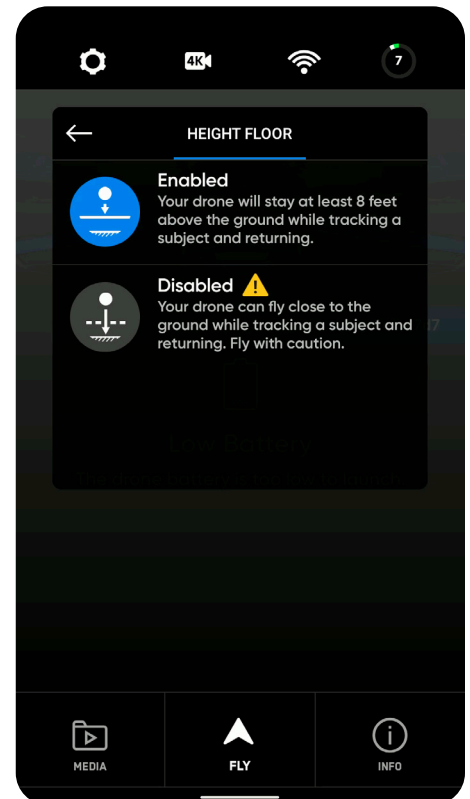

**NOTE:** The Height Floor setting only applies while a subject is being tracked. If Skydio is in manual flight mode with no subject selected, you always have full control over the drone's height.

# Pre-Flight

## Height Ceiling

- Enable Edit Height Ceiling to adjust the maximum allowed flight ceiling height between 30 ft (10 m) and 1500 ft (457 m).
- When disabled, the Height Ceiling is set at 400 ft (122 m).
- Height Ceiling selections will persist across flights and power cycles.

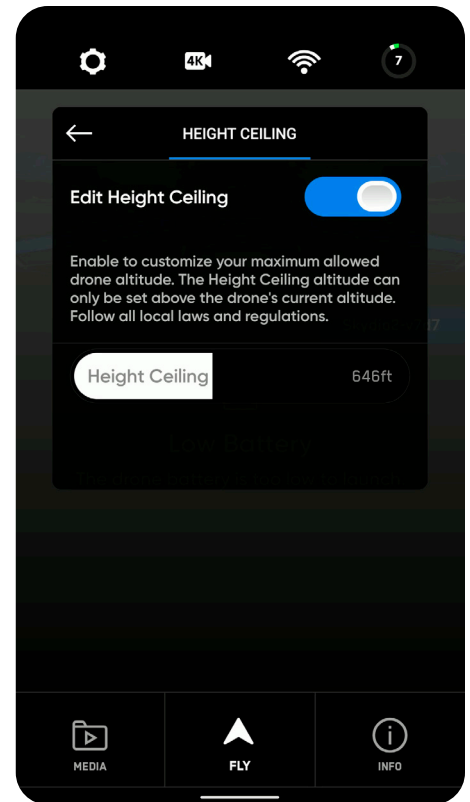

# Pre-Flight

## Drone Settings Menu

### Return Behavior

Customize the way Skydio behaves after initiating a return:

**Return Height** - Allows you to set the height to which Skydio should ascend before returning. By default, the Return Height is set to 32 ft (9.7 m). Skydio will ascend to that height before returning.

**Height Behavior** - Choose between Absolute and Relative

- **Absolute** means your drone will ascend to the specified Return Height **above the launch point** before returning. For example, if the Return Height is 32 ft and the drone is at 20 ft at the time the return is commanded, Skydio will ascend 12 ft before returning.
- **Relative** means your drone will ascend to the specified Return Height **above the current position** before returning. For example, if the Return Height is 32 ft and the drone is at 20 ft at the time the return is commanded, Skydio will ascend 32 ft and then return at a height of 52 ft.

**Drone Looks** - Skydio will either look toward or away from the return destination while returning.

**Return Speed** - Adjust the speed at which Skydio should fly when returning.

**Lost Connection** - Lets you choose how you want your drone to behave if the signal to your controlling device is lost:

- **Wait Before Return** - Specify the amount of time that you want Skydio to wait before it initiates a return flight, allowing time to reconnect.
- **Land Once Returned** - When enabled, Skydio will return, hover for a specified amount of time, and then land.
- **Wait Before Land** - Specify the amount of time between 0 to 300 seconds (the default is 240 seconds) that you want Skydio to wait before landing. This setting is only enabled when Land Once Return is toggled on.

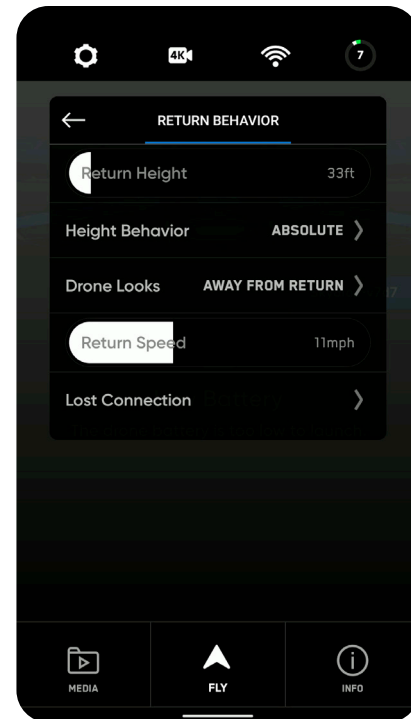

*Return Behavior settings*

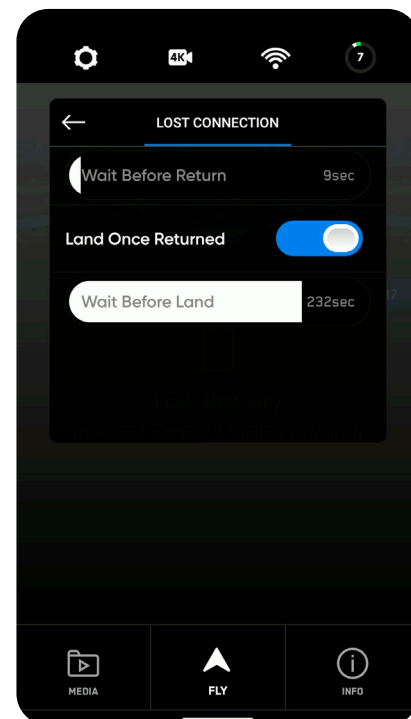

*Lost Connection return settings*

# Pre-Flight

---

## Drone Settings Menu

### Enable Narrow Band

Enable Narrow Band to provide additional wireless range.

- Extends controller range in open environments
- When enabled, the drone will switch to narrow band whenever applicable
- Video quality may suffer slightly



**NOTE:** *This setting is only available while connected to the controller or Beacon.*

# Pre-Flight

## Phone Settings Menu

### App Controls

- Slide (default) – Single stick with pitch and roll with yaw on separate buttons
- Steering – Single stick with pitch and yaw with roll on separate buttons
- Dual Sticks – Traditional Mode 2 dual-stick controls

### Dual Sticks Mode

- Sets the control style for the Dual Sticks app control setting. Allows you to choose between Mode 1, Mode 2 (default), and Mode 3 style controls

### On Screen Display

#### Telemetry

- Toggles the display of telemetry data during flight:
  - Current speed
  - Height above launch
  - Range from the launch point



**NOTE:** If you are piloting your drone using the on-screen controls your maximum speed 36 mph.

## Beacon Menu

When Beacon is connected, you will see a new tab under Device Settings which displays the battery percentage and current software version. You will not see this menu when Beacon is disconnected.



**NOTE:** Android users will not see the battery percentage.

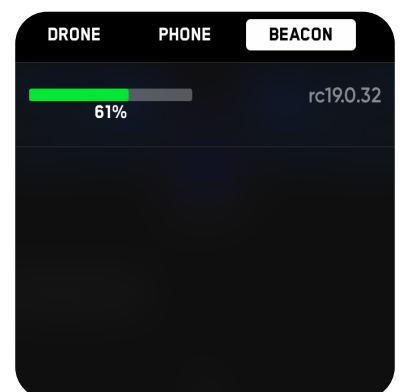
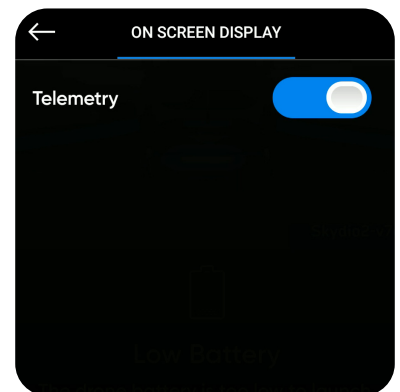
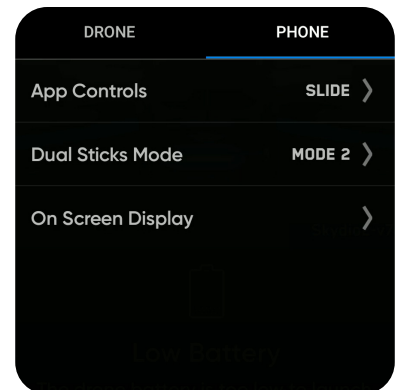

# Pre-Flight

## Controller Settings Menu

### Gimbal Speed

- Controls how quickly the camera gimbal pitches up and down

### Flight Speed

- Switch between default and custom sensitivity settings for the roll, pitch, yaw and throttle inputs
- Default settings are fixed and cannot be changed
- Custom settings may be adjusted

### Flight Mode

- Switch between Mode 1, Mode 2 (default), and Mode 3 style flight controls

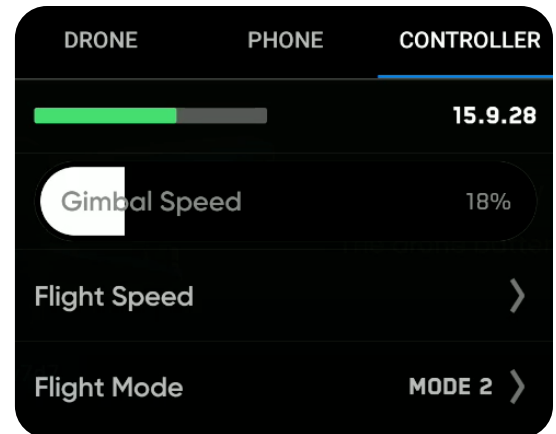

**NOTE:** Controller settings are only available when your Controller is connected to your drone. If you are piloting your drone using the Controller your maximum speed 36 mph.

### Mode 1

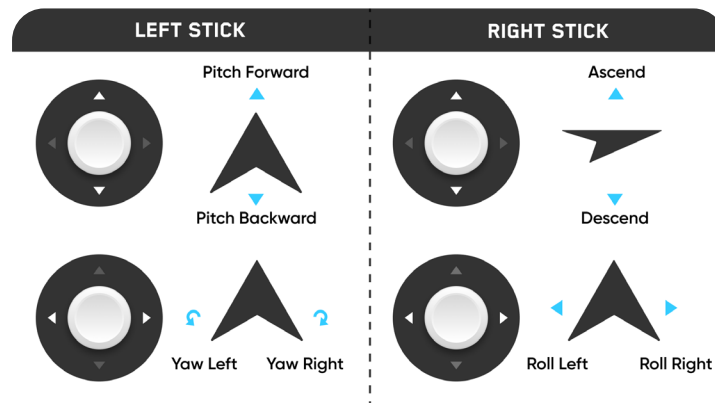

### Mode 2 (default)

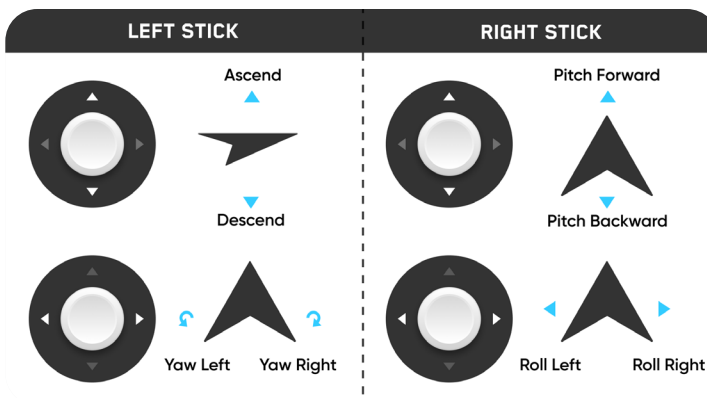

### Mode 3

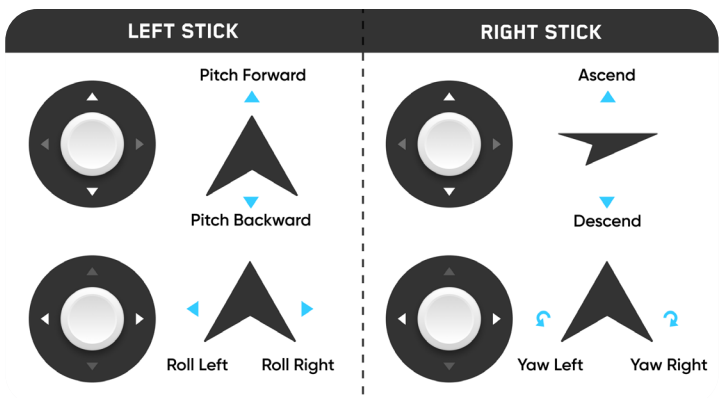



# Pre-Flight

## Anti-flicker

Adjust Anti-flicker settings if you experience flickering in your video. This setting is for users located outside of North America, in countries where the frequency of the alternating current in household electrical outlets is 50 Hz.

**Step 1** - Select the **INFO** menu

**Step 2** - Select your drone name

**Step 3** - Select **Anti-flicker**

These are standard 5 GHz WiFi channels that correspond to the following frequencies:

- **36:** 5180 MHz
- **40:** 5200 MHz
- **44:** 5220 MHz
- **48:** 5240 MHz
- **149:** 5745 MHz
- **153:** 5765 MHz
- **157:** 5785 MHz
- **161:** 5805 MHz
- **165:** 5825 MHz

Skydio recommends leaving Channel Selection set to Auto for best results.

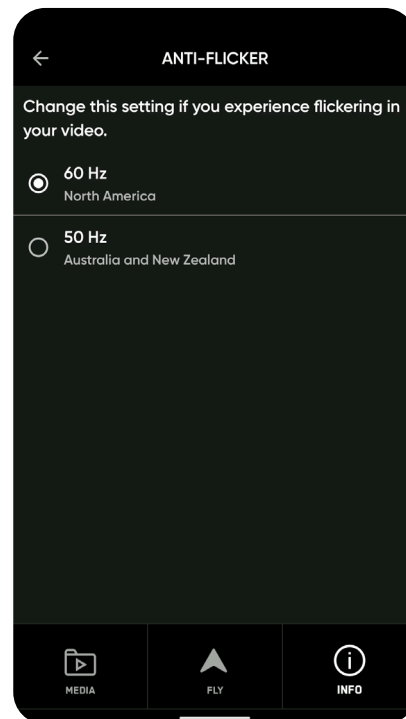
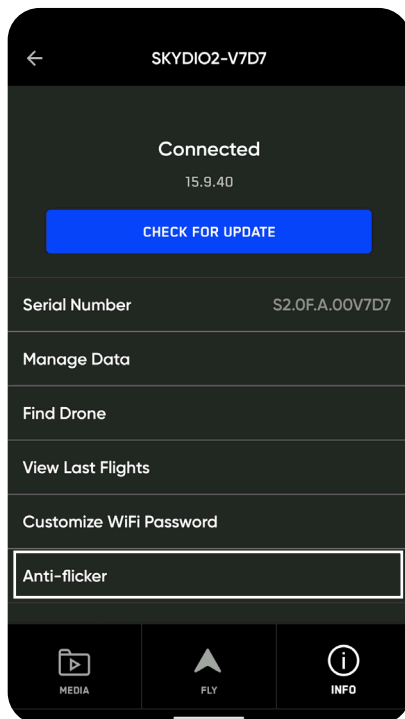

# Pre-Flight

## Channel Selection

By default, your Skydio 2/2+ will monitor signal interference and move to a clearer channel to improve wireless transmission signal quality during flight. You may override this by selecting your preferred channel.

**Step 1** - Select the **INFO** menu

**Step 2** - Select the name of your drone under **Devices**

**Step 3** - Scroll until you see **Channel Selection**

**Step 4** - Choose your desired radio frequency channel

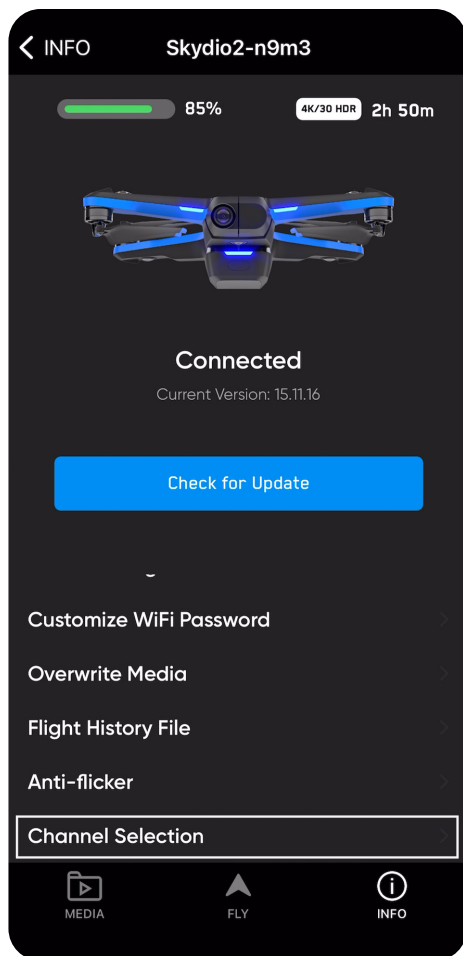

**NOTE:** You cannot change your radio channel while flying.

# Pre-Flight

## Return to Home

The Return to Home icon gives you the ability to have Skydio automatically return to either the launch location or your current location. Create a Home Point (or move the existing Home Point) by long-pressing on the map and selecting Set Home Point from the menu.

Home points are optional, set for each flight and not saved between flights. Skydio will automatically return to a set Home Point in the event of a loss of communication (unless otherwise specified in the waypoint settings). Tapping on a Home Point on the map gives you the option to fly the drone to that location immediately or remove it from the map.

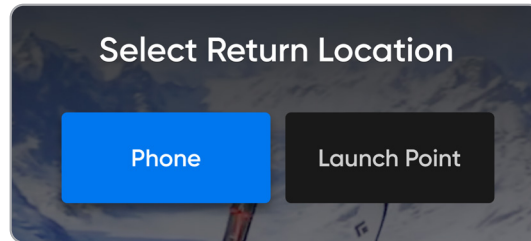

**NOTE:** Skydio must have a GPS signal at some point during the flight to create a Home Point. The better and more sustained the GPS signal, the more accurate Skydio flight will be when returning to that Home Point. If Skydio loses GPS or the GPS signal becomes weak, the drone will do its best to estimate and return to the Home Point position.

# Pre-Flight

## Map View

Select the map icon to enter the Map View. Your location, Skydio, and Launch Point location are all indicated on the map. To exit the Map View, tap the map icon again.



Skydio



Controller/  
Phone



Home Point



Launch Point



Beacon



# Pre-Flight

## Pre-flight Inspection

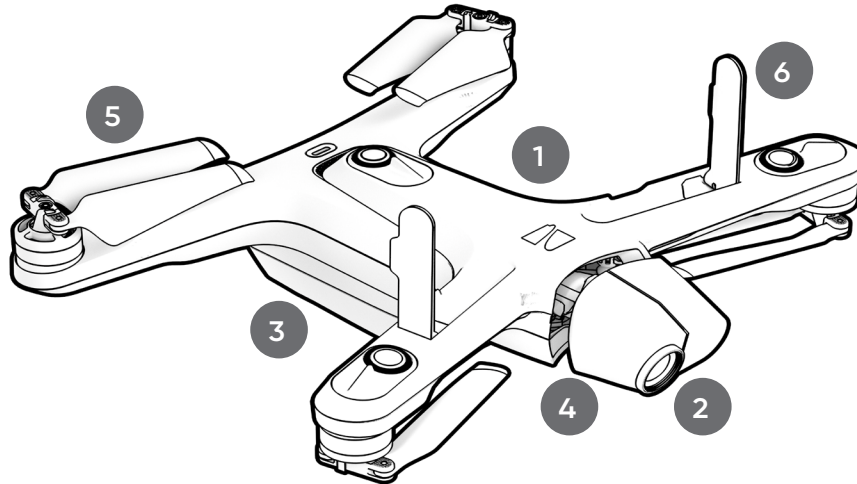

### 1. Inspect the body

- to ensure it is free of damage

### 2. Clean all camera lenses

- Skydio navigates visually, so it is essential to keep all camera lenses clean
- use a clean microfiber cloth to remove dust and smudges before every flight

### 3. Inspect the battery

- Skydio uses magnets to retain the battery which may attract metallic debris that could interfere with the seating of the battery
- visually inspect the battery, the battery tray, and the battery connection pins, to ensure that they are free of debris or damage
- verify the battery is fully seated in the aircraft prior to takeoff

### 4. Remove the gimbal clip

- remove the gimbal retaining clip from the front-facing camera before flight
- the gimbal will be slightly askew—this is normal behavior, and once in the air the gimbal will align itself
- reinsert the gimbal clip after flight

### 5. Inspect the propeller blades

- ensure that the propellers are firmly attached and free of nicks, cracks, or other visible damage
- do not fly with damaged propellers

### 6. Lift and inspect antennas (Skydio 2+ only)

- gently lift each antenna and guide it into a vertical position
- ensure antennas are free of damage

# Flight

## First flight

Before you begin your first flight, please read and follow all of the safety guidelines <https://skydio.com/safety>.

### Launch

**Step 1** - Find a clear area to launch

**Step 2** - Place your drone on a flat, stable surface

**Step 3** - Select **Launch** on the Fly screen or Press and hold the **Launch/Land** button on the Controller

- Skydio will ascend to 10 ft (3 m) and hover in place until you initiate a Skill or fly manually

**Step 4** - After launching, fly laterally to acquire a GPS lock. This is a critical step that must be taken if you are going to fly your drone over water.

**Confirm you have a GPS lock** by testing if your drone can ascend beyond 33 ft (10 m) above ground when outdoors.

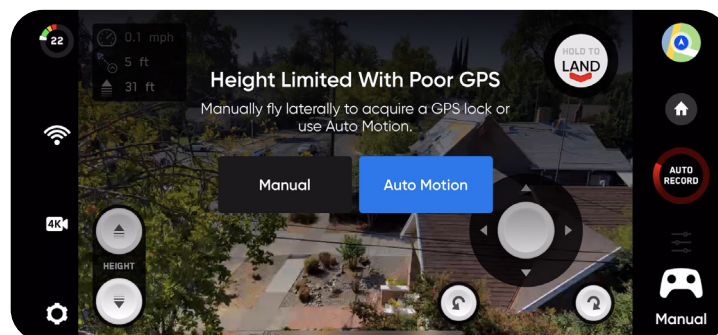
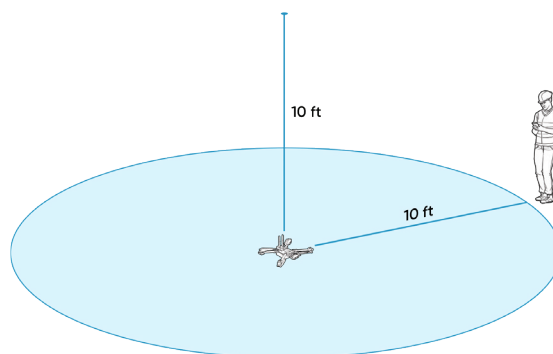

**CAUTION:** Failure to acquire a GPS lock prior to flight over water may result in erratic flight and/or emergency landing.



**NOTE:** Skydio requires a stable GPS connection for outdoor flight at an altitude greater than 33 ft (10 m) above its point of takeoff or the currently tracked subject. This may not be possible when flying in GPS denied environments such as indoors, heavy urban areas, and deep canyons; or when flying near large metal structures such as radio towers and bridges. Fly a few meters in a lateral motion (forward, backward, left, or right) to acquire a GPS lock. The indoor height ceiling is 66 ft (20 m) and can be toggled off.

# Flight

## Hand Launch



**WARNING:** Launching and landing Skydio from your hand is an advanced maneuver only to be used when it is necessary, and it is advised that you do so only if you are an experienced pilot. Exercise extreme care to avoid injury if the drone takes off from your hand. To avoid injury stay away from and do not touch rotating propellers when they are spinning. See safety guidelines at <https://skydio.com/safety>.

To complete a hand launch:

**Step 1** - Find an open area to launch, with clearance of 10 ft (3 m) above, 15 ft (4.5 m) in front, and 3 ft (1 m) on either side

- **Do not hand launch on windy days.** If there is any wind, for your safety ensure that it is not blowing towards you. If the wind is gusty or coming from different directions, consider a ground launch

**Step 2** - Lightly grip the battery keeping your fingers below the chassis and away from the propellers at all times

**Step 3** - Point the camera away from you

- Hold your drone at arm's length from your body, level and still
- Ensure that the rear propellers will not make contact with your arm

**Step 4** - Initiate a launch using the controller Launch/Land button

**Step 5** - Release Skydio carefully as the propellers begin to spin by slowly relaxing your grip.

- Keep your hand still - Skydio will slide off your palm and take flight on its own
- Do not push or throw the drone up in the air

# Flight

## Flight Screen

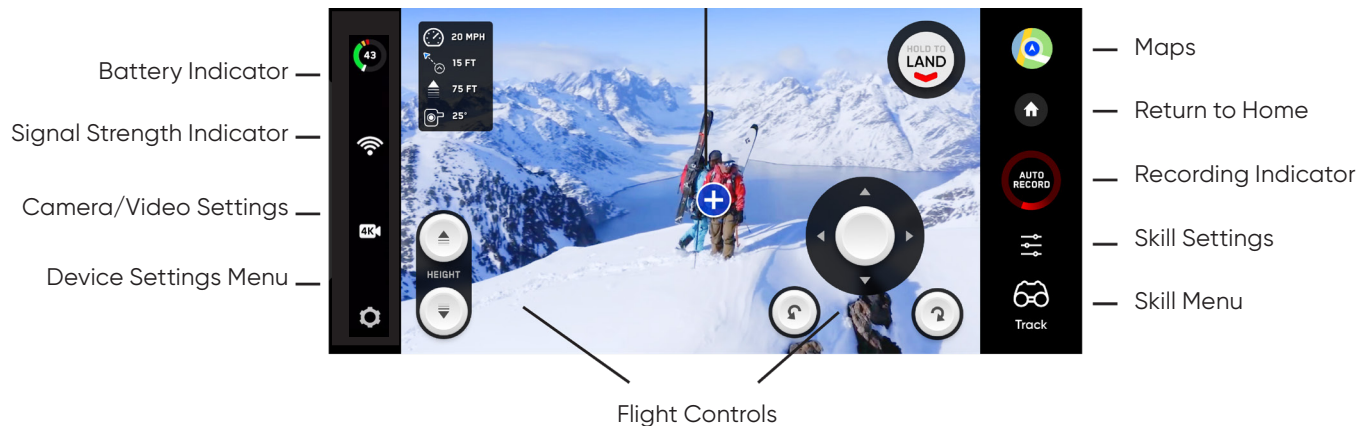

## Flight Controls

The on-screen flight controls are the primary method for controlling your drone during both autonomous and manual flight. Manual flight controls are the same in all skills and may be customized in the Phone tab of the device menu. Autonomous controls are unique for each skill.

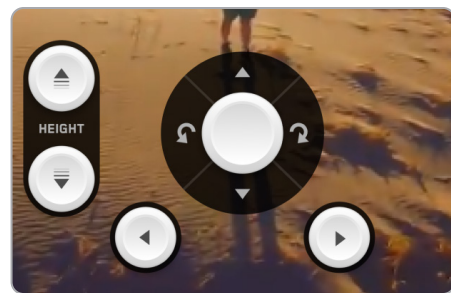

On-Screen Controls - customize in the Device Settings menu



Slide Controls (default)

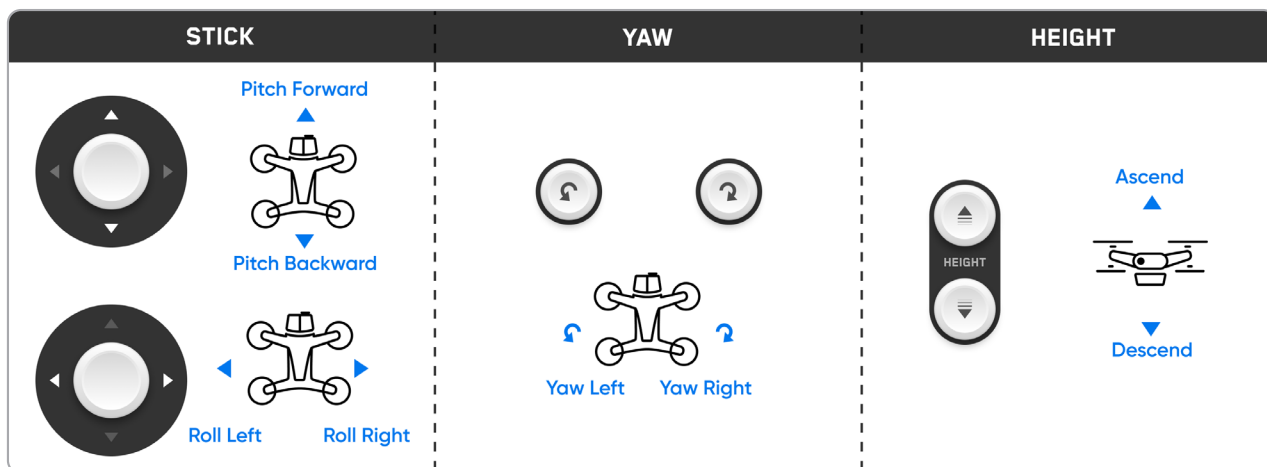



# Flight

## Touch Controls

- Drag vertically on-screen to increase or decrease gimbal pitch.
- Drag horizontally on-screen to adjust yaw.
- Pinch and drag your fingers to physically “zoom” in and out of the current view. This commands Skydio to fly directly forwards or backwards in relation to the current camera pitch.
- Double-tap anywhere on the flight screen to fly directly towards that spot.



**NOTE:** Flight Controls will not be displayed on-screen when flying with the Skydio Controller.

## Camera / Video Settings

Provides access to the camera settings and allows you to change between video and photo recording mode. Skydio can capture photos or video but not both at the same time. You may change your camera settings at any time before or during flight.

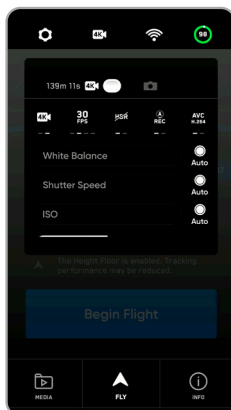

### Video Capture Settings

- Resolution
- Frame rate
- HDR On/Off\*
- Auto / Manual Recording
- Video Codec\*\*
- White Balance
- Shutter Speed
- ISO
- Exposure

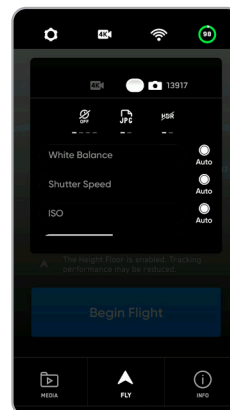

### Photo Capture Settings

- Photo Interval\*\*\*
  - Off / 1s or 2s\*\*\*\* / 5s / 10s
- HDR On/Off
- JPG / JPG+DNG\*\*\*\*\*
- White Balance
- Shutter Speed
- Exposure



**NOTE:** Changing the camera settings before launch may cause Skydio to return to the preflight screen and recalibrate its vision system.

# Flight

## Recording Indicator



Recording Video: Auto



Recording Video: Manual

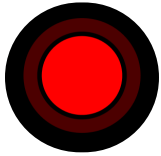

Recording Paused: Manual

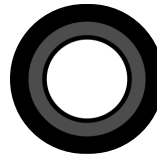
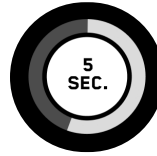

Photo Button



Interval Photos

\* HDR is not supported in all video resolutions and frame rates.

\*\* Skydio can record video in either AVC (H.264) or HEVC (H.265). Different mobile devices and personal computers have different compatibilities with these encoding standards. Be sure to choose the encoding standard that is best suited to your desired workflow.

\*\*\* When Photo Interval is enabled Skydio will continuously capture photos at the specified time interval until the setting is disabled or the flight ends.

\*\*\*\* The fastest interval photo setting when capturing in raw DNG is two seconds. Users may capture a photo every one second when capturing in JPG mode.

\*\*\*\*\* DNG photos are not displayed in the media tab of the Skydio 2 app and are retrieved directly from the microSD card.

# Flight

## Connection Strength Icon

Displays the current strength of the signal connection to Skydio while in flight. As the signal strength decreases, users may experience a lower quality video feed or a delay in their controls.



**NOTE:** Signal strength and maximum control range may be affected when flying in areas with electromagnetic interference.

View the strength of the connection between your controlling device and drone, as well as the GPS quality and the number of satellites your drone is connected to.

Select the **Connection Status icon** to display connected drone status, signal strength, GPS quality, and satellite count.

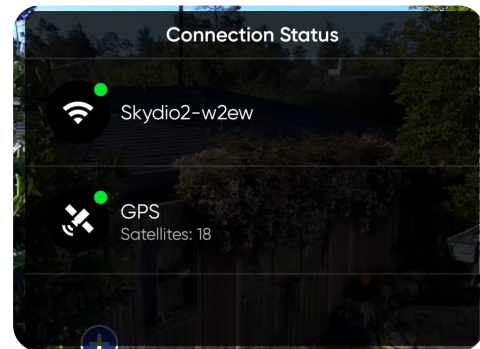

## Battery Indicator

Battery indicator messaging displays how much battery is available for flight, how much battery capacity available for a return trip, and how much battery is required to land.

- **Percentage** - displays battery charge remaining
- **Green** - indicates battery capacity for nominal flight before the time limit required to safely return and land
- **Yellow** - indicates how much battery capacity is required to safely return
- **Red** - indicates how much battery capacity is required to land
- **Countdown** - when battery capacity has less than two-minutes of flight time available for landing the indicator will change to a countdown
- **Alert symbol** - when battery capacity is too low to fly the indicator will change to an alert symbol and the drone will initiate a non-cancellable landing

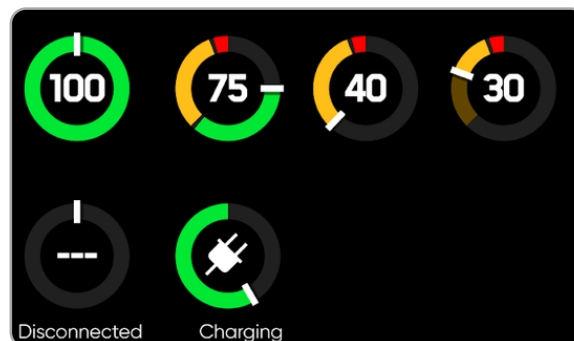

**NOTE:** As ground elevation and distance to home increase or decrease, Skydio takes this into account and adjusts the battery indicator accordingly.

# Flight

## Flight Skills

Skydio offers a range of autonomous flight skills:

- General
- Cinematic
- One-Shot
- Specialty

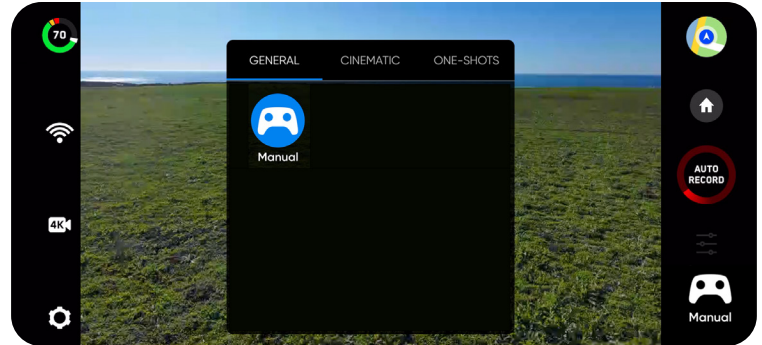

### Skills settings

Each skill may have its own custom settings which only affect the selected skill. Select the skill settings icon to customize each of the settings to suit your needs.



**NOTE:** Using the Beacon to perform General Skills is not supported, however Beacon will act as a range extender and allow you to control your Skydio up to 1.5 km away.

## General Skills



**Manual**

Traditional flying experience using on-screen controls or the Skydio Controller.



**NOTE:** If you are in the Manual Skill and piloting your drone using the on-screen controls, your maximum speed is reduced to 11 mph.

# Flight

## Cinematic Skills

Skydio offers unique camera views using autonomous flight and adjustable height and range settings to get the best shot.

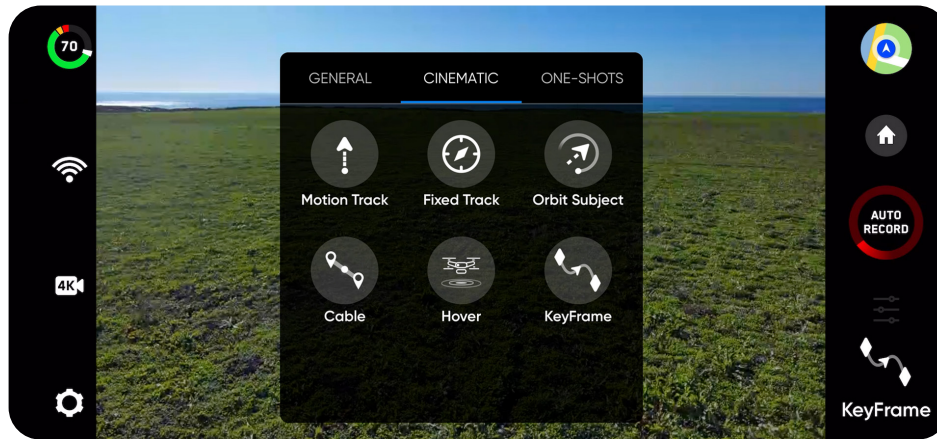

**Motion Track**

Skydio will track a subject from a specified angle relative to the subject's direction of motion, such as from the front, side or behind.



**Fixed Track**

Skydio will track a subject from a fixed angle regardless of which direction the subject is facing or moving.



**Orbit Subject**

Skydio will rotate around the selected subject in either a clockwise or counter-clockwise direction, keeping the subject in the center of the frame.



**Cable**

Mark two points in the sky and have Skydio fly along a fixed path between them. You can choose to track a subject while Skydio is on this fixed path.



**Hover**

Skydio will hover in a fixed position, as if affixed to a virtual tripod, rotating and tilting the camera to look at the subject as they move.





**KeyFrame**

Skydio will follow a custom flight path that you create by adding keyframes and adjusting the camera framing at each point. Repeat, reverse, speed up or slow down your sequence.

# Flight

## Tracking a Subject

**Subject Indicator** - Select the  or  icon to lock onto the subject. Selecting the indicator will command the Skydio to enter autonomous flight mode with the selected object as the tracking subject.



*Subject available for tracking*



*Subject actively tracked*

### Tips for Best Tracking Performance

- The Skydio can track a single person or vehicle at a time. Skydio does not track pets or other animals.
- The subject you wish to track must be visible in the camera view in order to become available for tracking.
- If the indicator is not appearing for the subject you wish to track, try moving the Skydio closer and ensure they are framed in the center of the camera view.

# Flight

---

## One-Shot Skills

One-Shots are special skills that perform a specific maneuver and then end, returning to the previously selected skill once the shot is complete.



**Dronie**

Skydio will fly up and outward, increasing in range, while continuing to track the subject.



**Rocket**

Skydio will fly straight up to capture a bird's eye overhead view of the subject.



**Boomerang**

Skydio rotates once around the subject, beginning close, flying outward, and finally returning close to the subject.



**Vortex**

Skydio will fly up and outward while rotating around the subject.

## Specialty Skills



**Learn**

*(Only available when using the Skydio 2 app on your phone)* Learn the basics of how to track subjects and control your drone. This tutorial appears automatically on your first flight, and you can repeat it at any time.

# Flight

## Land

To land your drone, stop subject tracking and manually fly the drone to a safe landing spot that is flat, clear of debris, avoiding people or animals. Press and hold the **LAND** button.



Skydio will descend to 10 ft (3 m) above the surface below it. When Skydio altitude falls below 10 ft (3 m) the lights will turn yellow and obstacle avoidance will be disabled for the remainder of the landing. An alert will display to notify you of the change in status.

While Skydio is landing you may nudge the drone forwards, backward, left, or right using the Controller or digital thumbsticks in the app.

You may also cancel any non-emergency landing by selecting the **Cancel** button before the landing completes.



**WARNING:** Skydio may recognize bushes, trees and similar obstacles as potential surfaces. Make sure to first pilot your drone to an open area free of obstacles before initiating a landing.



# Flight

## Case Landing

It is not always possible to find a clean, level area to land your Skydio. To initiate a case landing, the Skydio case must be in view of camera. A yellow ring will appear around the case in the live video feed to indicate that Skydio has identified the landing zone. If Skydio does not display the yellow ring, it will continue to descend straight down and land.



Piloting or nudging the drone during a case landing will cancel the case landing and continue with a normal landing.



**NOTE:** If a flight is initiated by taking off from a case (or a case is placed at the drone's exact launch point), GPS positional accuracy cannot be relied upon to guarantee a case landing when using the Return to Home function (or in the case of an RTH triggered by lost communication).

# Flight

## Hand Landing



**WARNING:** Do not attempt hand-landing Skydio before the lights turn yellow. Attempting to hand-land Skydio while Obstacle Avoidance is active will cause it to attempt to avoid your hand and may result in Skydio impacting yourself or another nearby object. To avoid injury stay away from and do not touch rotating propellers when they are spinning. Skydio does not recommend launching the drone while holding the drone in your hand.

**Step 1** – Ensure you have safe landing conditions

- Low winds
- Skydio is hovering stationary within a few feet of you and is no longer following a subject
- Skydio is over clear ground so that you have ample space to move

**Do not attempt a hand landing:**

- During high winds
- If Skydio is not stable in flight for any reason
- If Skydio is performing an emergency landing after an accident or crash
- You are in an area where you do not have stable footing
- You are on a moving vehicle or boat

**Step 2** – Rotate Skydio so that the camera is facing away from you

**Step 3** – Initiate a landing through the app, Beacon or Controller as you would normally

- **Do not attempt Skydio hand-landing without first initiating a landing. Doing so will result in the motors spinning at full speed and may cause severe injury.**
- Skydio will descend to 10 ft (3 m) above the surface below it. When Skydio is below 10 ft (3 m) level Skydio lights will turn yellow and obstacle avoidance will be disabled for the remainder of the landing. An alert will display to notify you of the change in status.
- **Do not attempt to hand-land Skydio before the lights turn yellow. Attempting to hand-land Skydio while obstacle avoidance is active will cause it to attempt to avoid your hand and may result in Skydio impacting yourself or another nearby object.**

**Step 4** – Move yourself into a position that will allow the drone to safely land in your hand

- You will be able to nudge the drone forwards, backward, left, or right using the Controller or digital thumbsticks in the app.
- The safest, and recommended, approach is to avoid nudging completely and adjust your position to meet the drone instead.

While landing, Skydio is looking for a stable, motionless surface to ensure that a safe touchdown has been achieved.

- Propellers will continue to spin for several seconds after touching down
- If Skydio is not level and motionless the motors may spin back up again. If this happens, maintain a firm grip on the battery to keep the drone flat and motionless.
- Do not rotate or flip the drone during a hand landing, as the battery may dislodge

# Post-flight

## Viewing and Saving Media

After Skydio has landed, select the Media tab of the Skydio 2 app to view your media. Skydio will begin syncing any audio and video captured during your flight – Skydio must stay powered on and connected to the app while this sync is in progress for audio to be saved. To save media directly to your mobile device's photo album:

**Step 1** - Select the **Media** menu

**Step 2** - Select and hold a file to enter selection mode

**Step 2** - Select all the media you wish to copy

**Step 3** - Select **Save to Phone**

- When utilizing Interval photo mode, all photos captured will appear as a single stack of photos. Selecting the stack will allow you to scroll through individual photos
- Only the JPG files can be viewed in Skydio 2 app
- Download the DNG image files directly from the SD card



**NOTE:** This method will not sync any recorded audio.

**Step 4** - (Optional) create a clip of the video to save instead of copying the entire video to your mobile device

- Skydio can record video in either AVC (H.264) or HEVC (H.265).
- Different mobile devices and personal computers have different compatibilities with these encoding standards.
- Attempting to save a video or make a clip with an encoding that is not compatible with your mobile device may cause playback issues.
- Creating a clip will sync any recorded audio into the new file. Use this method when you want to save videos with audio.



**NOTE:** Users can access the media tab while connected to the drone via the Skydio Controller or directly with the mobile device, but not when connected via the Beacon.

You may also connect Skydio to your personal computer via the USB-C port to view and copy your full-resolution video and photos directly off the microSD card. Connecting via USB to a computer that does not supply charging power will cause Skydio to run off battery power and may drain the battery.



**NOTE:** All photos taken by the Skydio have EXIF data embedded to enable post flight image analysis.

# Emergency Behaviors

Several of the emergency behaviors involve Skydio initiating an automatic Return to Home. Return Behaviors will be the same as a pilot-initiated return, and depending on your return settings, the drone will ascend before returning.

## Lost Connection

Skydio uses visual tracking, in combination with GPS and WiFi, to establish its position and keep track of its subject. Occasionally those signals can be obscured by the environment, especially when a subject is moving quickly.



*Obstacle Avoidance is still present, even when Skydio loses communication with the phone, Beacon, or Controller. If you do lose control, simply keep calm and let Skydio navigate home by itself.*

### When Following a subject

#### If Home Point is set

If you set a Home Point on the map within the Skydio 2 app and are tracking a subject, Skydio will continue to follow the subject for 20 seconds, or until the drone needs to return home due to a low battery (whichever occurs first). After tracking has stopped, Skydio will return to the Home Point.

#### If NO Home Point is set

If you did not set a Home Point and are tracking a subject, Skydio will continue to track for 20 seconds. After that time, it will return to the last location it was actively tracking a subject while connected.

### When NOT Following a subject

#### If Home Point is set

Skydio will return to the Home Point you have set.

#### If NO Home Point is set

If you do not have a Home Point set and you lose comms, Skydio will go to the last location that a subject was tracked since launch. If there was no subject tracked in this flight, Skydio will return to the launch point.

## Lost Connection Return Behaviors

Choose how you want your drone to behave if the signal to your controlling device is lost:

- **Wait Before Return** - set the amount of time that you want Skydio to wait before it initiates a return flight, allowing time to reconnect.
- **Land Once Returned** - when enabled, Skydio will return, hover for a specified amount of time, and then land.
- **Wait Before Land** - set the amount of time between 0 to 300 seconds (the default is 240 seconds) that you want Skydio to wait before landing. This setting is only enabled when **Land Once Return** is toggled on.

# Emergency Behaviors

## Lost GPS Behavior

In the event that the GPS signal is lost, Skydio will continue flying as normal. You will still be able to Return Home and select Fly Here Now on the map view, however Skydio flight will be less accurate.

If Skydio never obtains a strong GPS signal (it's either poor or non-existent throughout the flight), you may not be able to set a Home Point, Fly Here Now, or Return to Home/Phone.

Read [How does Skydio 2/2+ use GPS?](#) for more information on Skydio GPS capabilities.



**NOTE:** When Skydio is flying high up in the air or over large bodies of water, visual positioning becomes more difficult and the drone relies on GPS to assist with lateral positioning. In the event that GPS is lost in such conditions, Skydio lateral positioning will be affected and the drone may initiate an emergency landing.

## Low Battery Behavior

When your drone's battery is low, there will be a series of notifications and actions to ensure a safe landing:

- Skydio will assess your altitude and distance from the Home Point, then warn you when it is time to return home. It is recommended to you initiate a return or land at this time, however you can choose to keep flying.
- Skydio will then notify you when it has 2 minutes of flight time left based on its current altitude and the battery indicator will begin a two-minute countdown. You may choose to continue flying, however it is strongly recommended that you fly to a safe location and land.
- When the two-minute countdown is complete, Skydio will initiate an automatic landing that you will be unable to cancel. You will maintain the ability to nudge the drone in roll, pitch, and yaw to avoid any obstacles.



**NOTE:** Skydio will **not** automatically return to the home point when it reaches low battery. It will simply notify you that it's time to return, at which point you will need to command a return using the Return to Home button in the app or on the Skydio Controller.

## Emergency Flight Termination

When flying with a controller, you will now have the option to terminate your flight\* in the event of an extreme emergency. Simultaneously press and hold the **Land** and **Return** buttons on the controller for three seconds while in flight to immediately stop your drone's motors.



**WARNING:** Terminating a flight will cause your drone to crash. Damage resulting from Flight Termination is not covered under warranty and may result in injury or damage. Use only in extreme situations.

\*Only available when flying with the Skydio Controller.

# Emergency Behaviors

## Recovering a lost drone

In the event that your Skydio is lost, you may view its last known location:

**Step 1** - Select **INFO** menu

**Step 2** - Under **Devices**, select the name of your drone

**Step 3** - Select **Find Drone**

## View Last Flight

The View Last Flights feature is designed to assist you with locating your drone in the event of a crash, emergency landing, or low battery landing in an unintended location.

**Step 1** - Select **INFO** menu

**Step 2** - Select **Device Name**

**Step 3** - Select **View Last Flights**

- review video of the 10 most recent flights

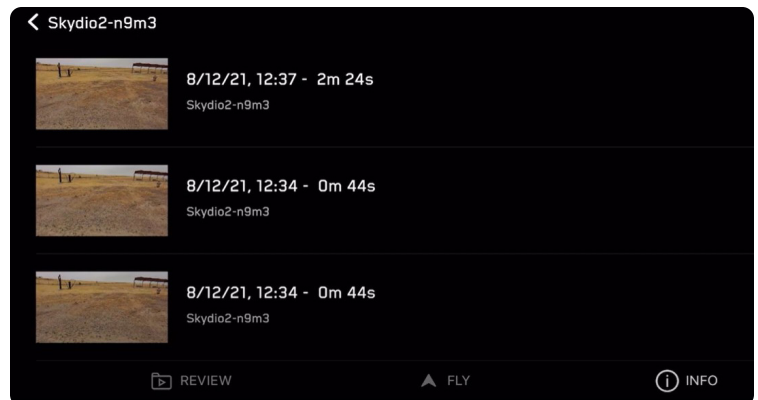
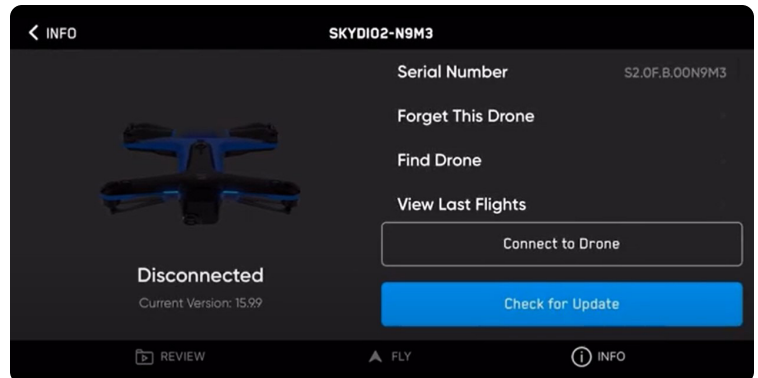

# Maintenance

---

## Battery safety guidelines

- Charge your Skydio batteries using only the Skydio supplied charging power adapter or dual charger accessory (dual charger sold separately). We recommend using the provided power adapter; however, most USB-C power adapters that are rated from 40W up to 100W should be compatible as well (charge time may be affected when using non-Skydio chargers).
- While charging, the Skydio or Dual Charger should be in an open area as it is normal for the device to become warm to the touch.
- TSA and FAA guidelines state that spare (uninstalled) lithium batteries must be transported in carry-on baggage only. When traveling with Skydio in the United States, be sure to pack your batteries in your carry-on luggage only. For more info, please see this [FAA page](#). When traveling with Skydio outside of the United States, check local regulations before transporting batteries.
- Do not use your Skydio batteries at temperatures below 32°F (0°C), as they will not function properly below that temperature. If your batteries do get cold, warm them up in a room-temperature environment - DO NOT use higher heat (hairdryer, etc.) to accelerate heating.
- Do not charge your batteries when ambient temperature is above 95°F (35°C) or below 50°F (10°C). Batteries will not charge when too hot or too cold.
- If storing your batteries long-term, we recommend fully charging and discharging them every two months.
- Store your batteries at room temperature (71°F - 82°F / 22°C - 28°C) and away from any moisture (less than 75% relative humidity).
- Do not use any batteries which have become dented or begin to split apart (after a crash or drop).
- Do not immerse the batteries, charger, or charging docks in water or other liquids.
- Lithium polymer batteries can leak, overheat, melt, release harmful gas, burst or ignite when exposed to heat, water, and other liquids or when pierced, punctured or ruptured.
- If any substances from the battery pack get into your eyes, do not rub them. Seek medical attention immediately.
- Take care when disposing of the battery pack. Contact your local waste facility to verify if lithium polymer batteries are permitted in your regular waste. Many stores also offer free recycling.
- Never insert any other materials into the Skydio battery terminals.

# Maintenance

## Replace Propeller Blades

Before every flight, inspect your Skydio propellers to ensure they are in good condition. If damaged, or you have flown your drone more than 25 hours, Skydio recommends replacing your propellers.

### Step 1 - Match propellers to hooks

- match props to the correct color hook (blue or gray)
- match the ring location (inner or outer) by flipping over the prop to locate

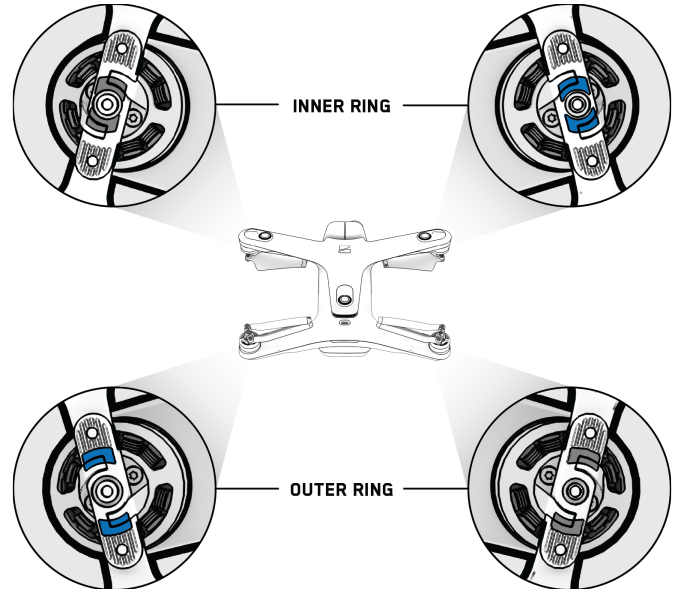

### Step 2 - Remove old propellers

- hold the motor with one hand
- push down and twist to release old propeller blade assembly

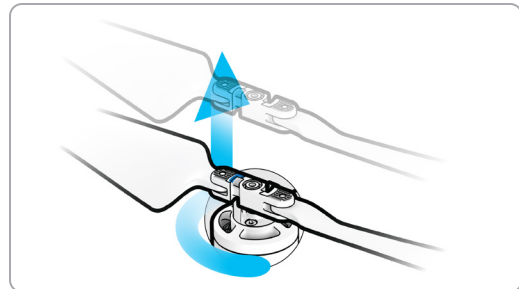

### Step 3 - Install new propellers

- hold the motor with one hand
- push down and twist to install new props

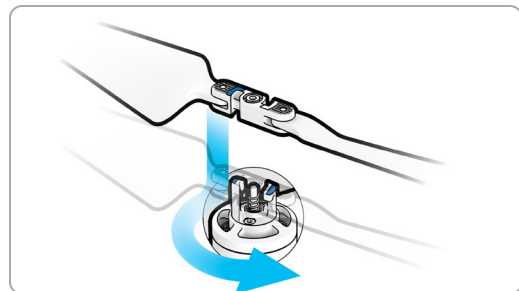



# Maintenance

## Updating Your Drone

Skydio is always improving and adding new features to Skydio. These improvements are enabled with periodic software updates for the Skydio 2 app, Skydio, and the Skydio Beacon and Controller.

Software updates for your drone and any Skydio accessories are delivered through the Skydio 2 app. When an update is available, you will receive a notification alert.

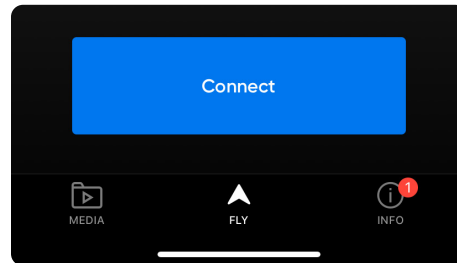

To install the update:

**Step 1** - Select the **INFO** menu

**Step 1** - Select **Devices**

**Step 2** - Select your drone

- follow the prompts to start the update
- the illustrations below are from an iOS device, but the process looks almost identical on an Android device

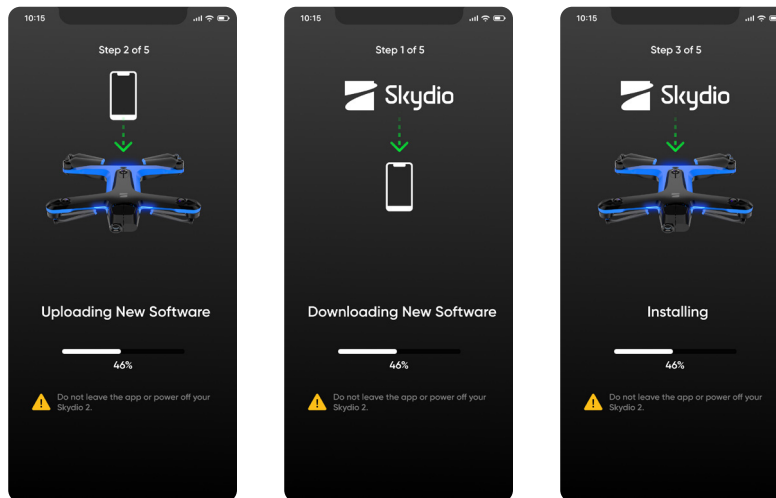

# Skydio 2 Specifications

## General

SIZE WITH BATTERY	223 x 273 x 74 mm (l x w x h)
SIZE WITHOUT BATTERY	223 x 273 x 43 mm (l x w x h)
SIZE OF INCLUDED HARD CASE	297 x 255 x 65 mm (l x w x h) (case fits: drone, spare propellers, charging cable, and either 2 batteries or 1 battery and 1 wall adapter.)
WEIGHT (WITH BATTERY)	775 g
FLIGHT TIME	23 minutes
MAX FLIGHT SPEED (SEA LEVEL, NO WIND)	36 mph (fully autonomous)
MAX WIND SPEED RESISTANCE	25 mph
MAX SERVICE CEILING (ABOVE SEA LEVEL)	15,000 ft density altitude
MAX FLIGHT ALTITUDE (FROM CONTROL DEVICE)	1,640 ft
OPERATIONAL TEMPERATURE RANGE	-5°C to 40°C

## Autonomy System

MAIN PROCESSOR	NVIDIA Tegra X2 SOC
GPU	256-core NVIDIA Pascal™ GPU
CPU	Dual-Core NVIDIA Denver 2 64-bit CPU Quad-Core ARM®-A57 MPCore
RAM	4GB 128-bit LPDDR4
OBSTACLE AVOIDANCE COVERAGE	Omnidirectional and above/below Super fisheye lenses for 360° view
3D WORLD MODEL UPDATE RATE	> 1 million points per second
WORLD MODEL-TO-ACTION UPDATE RATE	500 iterations per second
ONBOARD AI	9 custom deep networks used in flight
USER-SELECTABLE SUBJECTS FOR TRACKING	People and motor vehicles
OBJECT TRACKING AND IDENTIFICATION	Up to 10 simultaneous objects of interest
CALIBRATION	Automated online calibration of lens parameters, camera rotations, wind speed, and air density

# Skydio 2 Specifications

## Wireless & GPS

RANGE TO PHONE (LINE OF SIGHT, IDEAL CONDITIONS)	200 m
RANGE TO BEACON (LINE OF SIGHT, IDEAL CONDITIONS*)	Up to 1.5 km
RANGE TO CONTROLLER (LINE OF SIGHT, IDEAL CONDITIONS*)	Up to 3.5 km
OPERATING FREQUENCIES	2.4-2.483 GHz 5.18-5.24 GHz 5.725-5.85 GHz
CHANNEL WIDTH (STANDARD WIFI)	20, 40, and 80 MHz
CHANNEL WIDTH (SKYDIO LINK™)	5 and 10 MHz
GPS SATELLITE CONSTELLATIONS	GPS and GLONASS

*\*maximum range may be achieved under ideal conditions, which vary depending on weather, temperature, electromagnetic or other interference, visual line of sight, obstacles and other factors.*

## Navigation Camera System

CONFIGURATION	6x cameras in trinocular configuration top and bottom
SENSOR TYPE	Sony 1/3" 4K color CMOS
LENS APERTURE	f/1.8
FIELD-OF-VIEW	200°
ENVIRONMENT COVERAGE	True 360°
FRAME RATE	30 FPS

# Skydio 2 Specifications

## Primary Camera System

SENSOR TYPE	Sony IMX577 1/2.3" 12.3MP CMOS
SENSOR ACTIVE PIXELS	4056 (H) x 3040 (V)
LENS APERTURE	f/2.8
LENS FOCAL LENGTH	20mm (35mm format equivalent)
LENS DEPTH OF FIELD	1m - ∞
SHUTTER SPEED	electronic shutter 1 to 1/1920s
ISO RANGE	video 100-3200 photo 100-3200
EXPOSURE CONTROL	-2.0, -1.5, -1.0, -0.5, 0, 0.5, 1.0, 1.5, 2.0
IMAGE SIGNAL PROCESSOR	Qualcomm QCS605
GPU	Adreno™ 615
CPU	64-bit octa-core Kryo™ 300
DSP	Hexagon™ 685, 2x HVX
RESOLUTION AND MODES	3840x2160 30 fps 3840x2160 60 fps 3840x2160 48 fps 3840x2160 24 fps 1920x1080 120 fps 1920x1080 60 fps 1920x1080 30 fps
BITRATE	100 Mbps
VIDEO FORMAT	MPEG-4 (AVC/H.264, HEVC/H.265)
STILL RESOLUTION	4056x3040 (12 MP)
STILL FORMATS	JPEG, DNG (RAW)
STILL MODES	Single, Interval
DYNAMIC RANGE	13 stops
STORAGE	Removable Micro SD Card UHS Speed Class 3 / V30
STABILIZATION MECHANICAL RANGE	pitch ±124°, roll ±120°, yaw ±12.5°
PITCH CONTROLLABLE RANGE	-110° to +45°

# Skydio 2+ Specifications

## General

SIZE WITH BATTERY	223 x 273 x 74 mm (l x w x h)
SIZE WITHOUT BATTERY	223 x 273 x 43 mm (l x w x h)
SIZE OF INCLUDED HARD CASE	297 x 255 x 65 mm (l x w x h) (case fits: drone, spare propellers, charging cable, and either 2 batteries or 1 battery and 1 wall adapter.)
WEIGHT (WITH BATTERY)	775 g
FLIGHT TIME	27 minutes
MAX FLIGHT SPEED (SEA LEVEL, NO WIND)	36 mph (fully autonomous)
MAX WIND SPEED RESISTANCE	25 mph
MAX SERVICE CEILING (ABOVE SEA LEVEL)	15,000 ft density altitude
MAX FLIGHT ALTITUDE (FROM CONTROL DEVICE)	1,640 ft
OPERATIONAL TEMPERATURE RANGE	-5°C to 40°C

## Autonomy System

MAIN PROCESSOR	NVIDIA Tegra X2 SOC
GPU	256-core NVIDIA Pascal™ GPU
CPU	Dual-Core NVIDIA Denver 2 64-bit CPU Quad-Core ARM®-A57 MPCore
RAM	4GB 128-bit LPDDR4
OBSTACLE AVOIDANCE COVERAGE	Omnidirectional and above/below Super fisheye lenses for 360° view
3D WORLD MODEL UPDATE RATE	> 1 million points per second
WORLD MODEL-TO-ACTION UPDATE RATE	500 iterations per second
ONBOARD AI	9 custom deep networks used in flight
USER-SELECTABLE SUBJECTS FOR TRACKING	People and motor vehicles
OBJECT TRACKING AND IDENTIFICATION	Up to 10 simultaneous objects of interest
CALIBRATION	Automated online calibration of lens parameters, camera rotations, wind speed, and air density

# Skydio 2+ Specifications

## Wireless & GPS

RANGE TO PHONE (LINE OF SIGHT, IDEAL CONDITIONS)	200 m
RANGE TO BEACON (LINE OF SIGHT, IDEAL CONDITIONS*)	Up to 3 km
RANGE TO CONTROLLER (LINE OF SIGHT, IDEAL CONDITIONS*)	Up to 6 km
OPERATING FREQUENCIES	5.18–5.24 GHz 5.725–5.85 GHz
CHANNEL WIDTH (STANDARD WIFI)	20, 40, and 80 MHz
CHANNEL WIDTH (SKYDIO LINK™)	5 and 10 MHz
GPS SATELLITE CONSTELLATIONS	GPS and GLONASS

*\*maximum range may be achieved under ideal conditions, which vary depending on weather, temperature, electromagnetic or other interference, visual line of sight, obstacles and other factors.*

## Navigation Camera System

CONFIGURATION	6x cameras in trinocular configuration top and bottom
SENSOR TYPE	Sony 1/3" 4K color CMOS
LENS APERTURE	f/1.8
FIELD-OF-VIEW	200°
ENVIRONMENT COVERAGE	True 360°
FRAME RATE	30 FPS

# Skydio 2+ Specifications

## Primary Camera System

SENSOR TYPE	Sony IMX577 1/2.3" 12.3MP CMOS
SENSOR ACTIVE PIXELS	4056 (H) x 3040 (V)
LENS APERTURE	f/2.8
LENS FOCAL LENGTH	20mm (35mm format equivalent)
LENS DEPTH OF FIELD	1m - ∞
SHUTTER SPEED	electronic shutter 1 to 1/1920s
ISO RANGE	video 100-3200 photo 100-3200
EXPOSURE CONTROL	-2.0, -1.5, -1.0, -0.5, 0, 0.5, 1.0, 1.5, 2.0
IMAGE SIGNAL PROCESSOR	Qualcomm QCS605
GPU	Adreno™ 615
CPU	64-bit octa-core Kryo™ 300
DSP	Hexagon™ 685, 2x HVX
RESOLUTION AND MODES	3840x2160 30 fps 3840x2160 60 fps 3840x2160 48 fps 3840x2160 24 fps 1920x1080 120 fps 1920x1080 60 fps 1920x1080 30 fps
BITRATE	100 Mbps
VIDEO FORMAT	MPEG-4 (AVC/H.264, HEVC/H.265)
STILL RESOLUTION	4056x3040 (12 MP)
STILL FORMATS	JPEG, DNG (RAW)
STILL MODES	Single, Interval
DYNAMIC RANGE	13 stops
STORAGE	Removable Micro SD Card UHS Speed Class 3 / V30
STABILIZATION MECHANICAL RANGE	pitch ±124°, roll ±120°, yaw ±12.5°
PITCH CONTROLLABLE RANGE	-110° to +45°

# Legal

---

## Compliance Information

### FCC

Any changes or modifications to this equipment not expressly approved by Skydio for compliance will void the user's authorization to operate this equipment.

This equipment has been tested and found to comply with the limits for a Class B digital device, pursuant to part 15 of the FCC Rules. These limits are designed to provide reasonable protection against harmful interference in a residential installation. This equipment generates, uses and can radiate radio frequency energy and, if not installed and used in accordance with the instructions, may cause harmful interference to radio communications. However, there is no guarantee that interference will not occur in a particular installation. If this equipment does cause harmful interference to radio or television reception, which can be determined by turning the equipment off and on, the user is encouraged to try to correct the interference by one or more of the following measures:

- Reorient or relocate the receiving antenna
- Increase the separation between the equipment and receiver
- Connect the equipment into an outlet on a circuit different from that to which the receiver is connected
- Consult the dealer or experienced radio/TV technician for help

This device complies with part 15 of the FCC Rules. Operation is subject to the following two conditions: (1) This device may not cause harmful interference, and (2) this device must accept any interference received, including interference that may cause undesired operation.

This equipment complies with FCC radiation exposure limits set forth for an uncontrolled environment. The distance between user and products should be no less than 20cm. The end user must follow the specific operating instruction for satisfying RF exposure compliance. This transmitter must not be co-located or operating in conjunction with any other antenna or transmitter

### California Prop 65 Warning

Lithium-ion Batteries and/or products that contain Lithium-ion Batteries can expose you to chemicals including cobalt lithium nickel oxide, and nickel, which are known to the State of California to cause cancer and birth defects or other reproductive harm. For more information, visit [www.P65Warnings.ca.gov](http://www.P65Warnings.ca.gov)

### IC

This device contains licence-exempt transmitter(s)/receiver(s) that comply with Innovation, Science and Economic Development Canada's licence-exempt RSS(s). Operation is subject to the following two conditions:

- This device may not cause interference
- This device must accept any interference, including interference that may cause

L'émetteur/récepteur exempt de licence contenu dans le présent appareil est conforme aux CNR d'Innovation, Sciences et Développement économique Canada applicables aux appareils radio exempts de licence.

L'exploitation est autorisée aux deux conditions suivantes:

- L'appareil ne doit pas produire de brouillage
- L'appareil doit accepter tout brouillage radioélectrique subi, même si le brouillage est susceptible d'en compromettre le fonctionnement



